

Group 3 Gear Pumps

Technical Information

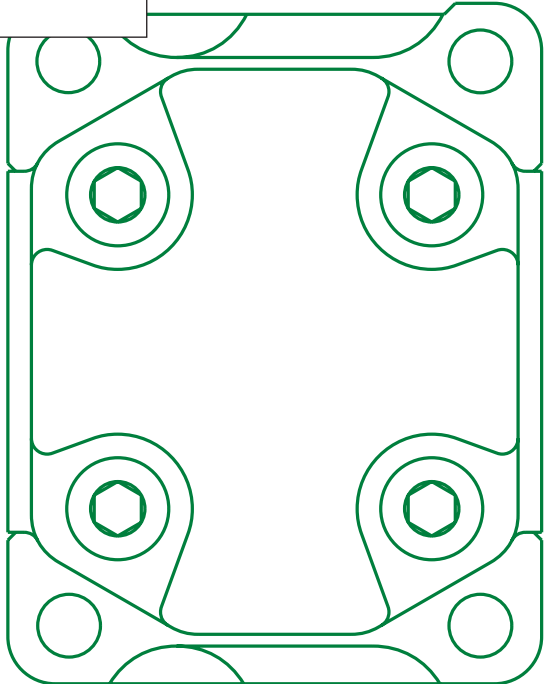
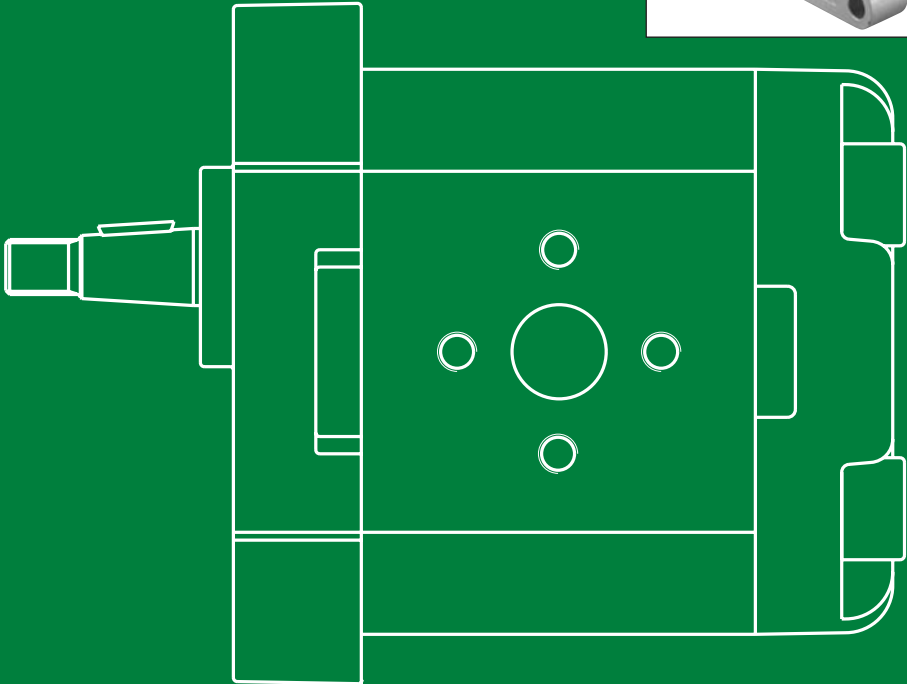
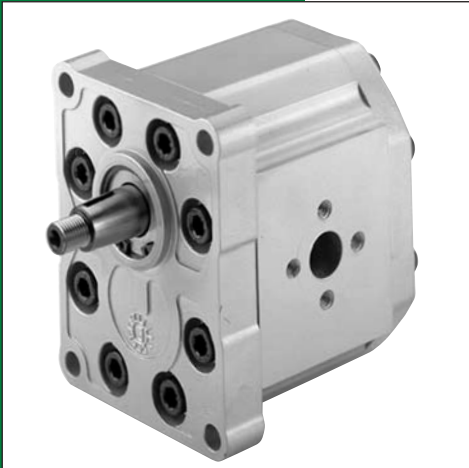
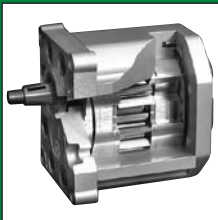

Group 3 Gear Pumps

Technical Information

General Information

History of revisions

Table of revisions

Date	Page	Changed	Rev.
28, June 2010	-	First edition	A

Reference documents

Literature reference for gear products

Title	Type	Order number
General Aluminum Gear Pumps and Motors	Technical Information	L1016238
Group 1 Gear Pumps	Technical Information	L1016399
Group 2 Gear Pumps	Technical Information	L1016341
Group 1, 2 and 3 Gear Motors	Technical Information	L1016082
Hydraulic Fluids and Lubricants	Technical Information	L1021414
Experience with Biodegradable Hydraulic Fluids	Technical Information	L1021903

© 2010 Turolla OpenCircuitGearTM. All rights reserved.

Turolla OCG accepts no responsibility for possible errors in catalogs, brochures and other printed material. Turolla OCG reserves the right to alter its products without prior notice. This also applies to products already ordered provided that such alterations can be made without affecting agreed specifications. All trademarks in this material are properties of their respective owners. Sauer-Danfoss, Turolla, Turolla OpenCircuitGear, Turolla OCG, OpenCircuitGear, Fast Lane and PLUS+1 are trademarks of the Sauer-Danfoss Group.

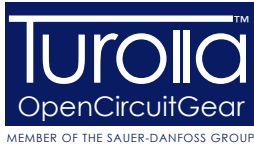

Group 3 Gear Pumps Technical Information Contents

General Information	Overview	4
	Features	4
	Pump displacements	4
	Group 3 gear pumps` attributes.....	4
	SEP3NN	5
	SNP3NN	5
	Pump design	5
	Gear pump in circuit.....	5
	Technical data.....	6
	Determination of nominal pump sizes.....	7
	Based on SI units/Based on US units.....	7
Product Coding	Model code.....	8
System Requirements	Pressure.....	10
	Speed.....	10
	Hydraulic fluids.....	11
	Temperature and viscosity.....	11
	Filtration.....	12
	Filters	12
	Selecting a filter.....	12
	Reservoir	13
	Line sizing	13
	Pump drive	14
	Pump drive data form.....	15
	Pump life.....	16
	Sound levels	17
Pump Performance	Pump performance graphs.....	18
Product Options	Shaft, flange, and port configurations.....	22
	Mounting flanges	23
	Shaft options.....	23
	Port configurations	24
	Porting.....	25
Dimensions	SNP3NN – 01FA, 01DA, 01BA / SEP3NN – 01BA	26
	SNP3NN – 02FA, 02DA and 02BA	27
	SNP3NN – 03FB, 03BB	28
	SNP3NN – 06DD, 06AA	29
	SNP3NN and SEP3NN – 07SA, 07GA	30

Group 3 Gear Pumps Technical Information General Information

Overview

The Turolia OCG Group 3 is a range of peak performance fixed-displacement gear pumps. Constructed of a high-strength extruded aluminum body with aluminum cover and flange, all pumps are pressure-balanced for exceptional efficiency.

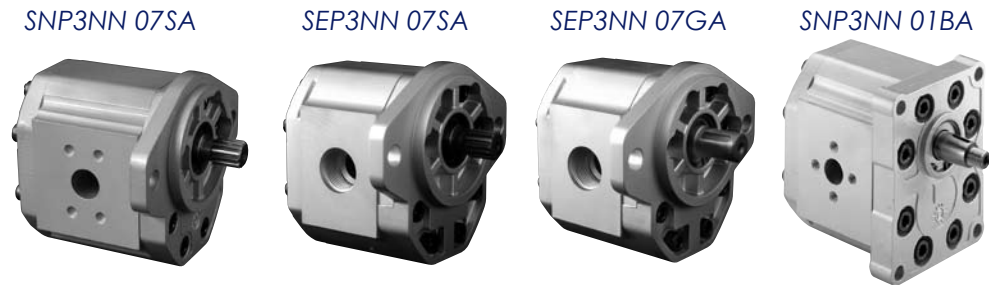

Features

Group 3 gear pumps` attributes

- Wide range of displacements from 22 to 90 cm³/rev [from 1.34 to 5.49 in³/rev]
- Continuous pressure rating up to 250 bar [3625 psi]
- Speeds up to 3000 min⁻¹ (rpm)
- SAE, DIN and European standard mounting flanges
- High quality case hardened steel gears
- Multiple pump configurations in combination with SNP1NN, SNP2NN and SNP3NN

Pump displacements

Quick reference chart for pump displacements vs. rated pressure

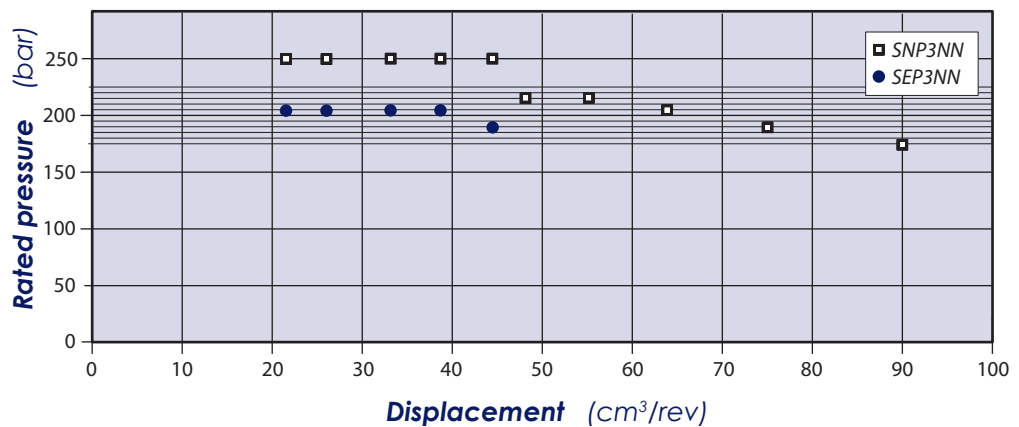

Group 3 Gear Pumps Technical Information General Information

Pump design

SEP3NN

The SEP3NN gear pump is available in a limited displacement range from 22.0 to 44.1 cm³/rev [from 1.34 to 2.69 in³/rev]. Suitable for applications where the pressure is lower than 210 bar [3045 psi], the SEP3NN range is released into SAE and European configurations. The overall length is reduced by 12 mm [0.47 in] in respect of the SNP3NN.

SNP3NN

The SNP3NN is available in the full displacement range from 22.0 to 88.2 cm³/rev [from 1.34 to 5.38 in³/rev], and with higher pressure ratings than the SEP3NN. This is due to the pressure balance on each side of the gears obtained with pressure-balance plates made in antifriction alloy that contribute to high volumetric efficiency and maximum sealing as well.

SNP3NN 01BA (cut away)



Technical data

Technical data for SNP3NN

SNP3NN pump model		Frame size									
		022	026	033	038	044	048	055	063	075	090
Displacement	cm ³ /rev	22.1	26.2	33.1	37.9	44.1	48.3	55.1	63.4	74.4	88.2
	[in ³ /rev]	[1.35]	[1.60]	[2.02]	[2.32]	[2.69]	[2.93]	[3.36]	[3.87]	[4.54]	[5.38]
Peak pressure	bar [psi]	270	270	270	270	270	250	250	230	200	170
		[3910]	[3910]	[3910]	[3910]	[3910]	[3625]	[3625]	[3350]	[2910]	[2465]
Rated pressure	bar [psi]	250	250	250	250	250	230	230	210	180	150
		[3625]	[3625]	[3625]	[3625]	[3625]	[3350]	[3350]	[3045]	[2610]	[2175]
Minimum speed	min ⁻¹ (rpm)	800	800	800	800	800	800	800	600	600	600
Maximum speed		3000	3000	3000	3000	3000	3000	2500	2500	2500	2500
Weight	kg [lb]	6.8	6.8	7.2	7.3	7.5	7.6	7.8	8.1	8.5	8.9
		[15.0]	[15.0]	[15.8]	[16.1]	[16.5]	[16.8]	[17.3]	[17.9]	[18.7]	[19.6]
Moment of inertia of rotating components	x 10 ⁻⁶ kg·m ² [x 10 ⁻⁶ lbf·ft ²]	198	216	246	267.2	294.2	312.2	342.3	378.3	426.4	486.5
		[4698]	[5126]	[5838]	[6340]	[6891]	[7408]	[8123]	[8977]	[10118]	[11545]
Theoretical flow at maximum speed	l/min [US gal/min]	66.3	78.6	99.3	113.7	132.3	144.9	137.8	158.5	186	220.5
		[17.5]	[20.8]	[26.2]	[30.0]	[35.0]	[38.3]	[36.4]	[41.8]	[49.1]	[58.3]

Technical data for SEP3NN

SEP3NN pump model		Frame size				
		022	026	033	038	044
Displacement	cm ³ /rev	22.1	26.2	33.1	37.9	44.1
	[in ³ /rev]	[1.35]	[1.60]	[2.02]	[2.32]	[2.69]
Peak pressure	bar [psi]	230	230	230	230	200
		[3350]	[3350]	[3350]	[3350]	[2910]
Rated pressure	bar [psi]	210	210	210	210	180
		[3045]	[3045]	[3045]	[3045]	[2610]
Minimum speed	min ⁻¹ (rpm)	1000	1000	1000	1000	800
Maximum speed		3000	3000	3000	2800	2600
Weight	kg [lb]	5.7	5.8	6.1	6.2	6.4
		[12.57]	[12.79]	[13.45]	[13.67]	[14.11]
Moment of inertia of rotating components	x 10 ⁻⁶ kg·m ² [x 10 ⁻⁶ lbf·ft ²]	198	216	246	294.2	312.2
		[4698]	[5126]	[5873]	[6981]	[7408]
Theoretical flow at maximum speed	l/min [US gal/min]	66.3	78.6	99.3	113.7	132.3
		[17.5]	[20.8]	[26.2]	[30.0]	[35.0]

ⓘ Caution

The rated and peak pressure mentioned are for pumps with flanged ports only. When threaded ports are required a de-rated performance has to be considered. To verify the compliance of an high pressure application with a threaded ports pump apply to a Turolla OCG representative.

Determination of nominal pump sizes

Use these formulae to determine the nominal pump size for a specific application:

Based on SI units

Based on US units

Output flow: $Q = \frac{V_g \cdot n \cdot \eta_v}{1000} \text{ l/min}$

$Q = \frac{V_g \cdot n \cdot \eta_v}{231} \text{ [US gal/min]}$

Input torque: $M = \frac{V_g \cdot \Delta p}{20 \cdot \pi \cdot \eta_m} \text{ N}\cdot\text{m}$

$M = \frac{V_g \cdot \Delta p}{2 \cdot \pi \cdot \eta_m} \text{ [lb}\cdot\text{in]}$

Input power: $P = \frac{M \cdot n}{9550} = \frac{Q \cdot \Delta p}{600 \cdot \eta_t} \text{ kW}$

$P = \frac{M \cdot n}{63.025} = \frac{Q \cdot \Delta p}{1714 \cdot \eta_t} \text{ [hp]}$

Variables: SI units [US units]

V_g	= Displacement per rev.	cm ³ /rev [in ³ /rev]
p_{HD}	= Outlet pressure	bar [psi]
p_{ND}	= Inlet pressure	bar [psi]
Δp	= $p_{HD} - p_{ND}$	bar [psi]
n	= Speed	min ⁻¹ (rpm)
η_v	= Volumetric efficiency	
η_m	= Mechanical (torque) efficiency	
η_t	= Overall efficiency ($\eta_v \cdot \eta_m$)	

Group 3 Gear Pumps

Technical Information

Product Coding

Model code

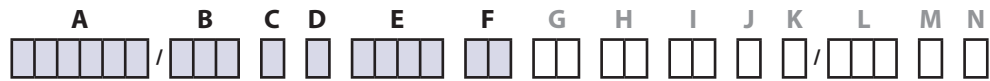

A Type

SNP3NN	Standard gear pump
SEP3NN	Medium pressure gear pump

B Displacement

022	22.1 cm ³ /rev [1.35 in ³ /rev]
026	26.2 cm ³ /rev [1.60 in ³ /rev]
033	33.1 cm ³ /rev [2.02 in ³ /rev]
038	37.9 cm ³ /rev [2.32 in ³ /rev]
044	44.1 cm ³ /rev [2.69 in ³ /rev]
048	48.3 cm ³ /rev [2.93 in ³ /rev]
055	55.1 cm ³ /rev [3.36 in ³ /rev]
063	63.4 cm ³ /rev [3.87 in ³ /rev]
075	74.4 cm ³ /rev [4.54 in ³ /rev]
090	88.2 cm ³ /rev [5.38 in ³ /rev]

C Direction of rotation

R	Right hand (clockwise)
L	Left hand (counterclockwise)
B	For reversible motors

D Version

N	Standard gear pump
----------	--------------------

F Rear cover

P1	Standard cover for pump
-----------	-------------------------

E Mounting flange and drive gear

Code	Description (Type of flange • type of drive gear • preferred ports for configuration)	SNP3NN	SEP3NN
01FA	European four bolt flange • Parallel shaft • European flanged ports	●	-
01BA	European four bolt flange • Tapered 1:8 shaft • European flanged ports	●	●
01DA	European four bolt flange • Splined 15T 12x10 shaft • European flanged ports	●	-
02BA	European four bolts flange • Tapered 1:8 shaft • European flanged ports	●	-
02DA	European four bolts flange • DIN splined shaft • European flanged ports	●	-
02FA	European four bolts flange • Parallel shaft • European flanged ports	●	-
03BB	European four bolts flange • Tapered 1:8 shaft • European flanged ports	●	-
03FB	European four bolts flange • Parallel shaft • European flanged ports	●	-
06AA	German four bolts flange • Tapered 1:5 shaft • German standard ports	●	-
06DD	German four bolts flange • DIN Splined shaft • German flanged ports	●	-
07GA	SAE B flange • Parallel shaft • Vertical four bolt SAE flanged ports	●	-
07SA	SAE B flange • SAE splined shaft • Vertical four bolt SAE flanged ports	●	●

Legend:

●	Standard
○	Optional
-	Not Available

Model code (continued)



G Inlet port

Code	Description	
A2	8,5x22,23x47,63x 3/8 -16UNC	SAE flanged port
A3	25x26,19x52,37x 3/8 -16UNC	
A4	31x30,18x58,72x 7/16 -14UNC	
A5	37,5/27x35,7x69,85x 1/2 -13UNC	
B7	20x40xM6	Flanged port with thd holes in X pattern
BA	18x55xM8	
BB	27x55xM8	
BC	36/27x55xM8	
C3	13,5x30xM6	Flanged port with thd holes in + pattern
C7	20x40xM8	
CA	27x51xM10	
CD	36x62xM10	
E6	1 1/16-12UN	Thd SAE O-ring boss port
E8	1 5/16-12UN	
E9	1 5/8-12UN	
EA	1 7/8-12UN	
F5	3/4 GAS	Threaded GAS (BSPP)
F6	1 GAS	
F7	1 1/4 GAS	

H Outlet port

For code letters and descriptions see *the table above*.

I Port position and variant body

NN	Standard gear pump from catalogue
-----------	-----------------------------------

L Set valve

NNN	No valve
V**	Integral RV-pressure setting. Pump speed for relief valve setting

J Sealing

N	Standard Buna seal
A	Without shaft seal
B	VITON seals

M Marking

N	Standard marking
A	Standard marking + customer code
Z	Without marking

K Screws

N	Standard screws
A	Galvanized screws+nuts-washers
B	DACROMET/GEOMET screws

N Mark position

N	Standard marking position
A	Mark on the bottom referring to drive gear

Group 3 Gear Pumps Technical Information System Requirements

Pressure

The inlet vacuum must be controlled in order to realize expected pump life and performance. The system design must meet inlet pressure requirements during all modes of operation. Expect lower inlet pressures during cold start. It should improve quickly as the fluid warms.

Peak pressure is the highest intermittent pressure allowed. The relief valve overshoot (reaction time) determines peak pressure. It is assumed to occur for less than 100 ms. *The illustration to the right* shows peak pressure in relation to rated pressure and reaction time (100 ms maximum).

Rated pressure is the average, regularly occurring, operating pressure that should yield satisfactory product life. The maximum machine load demand determines rated pressure. For all systems, the load should move below this pressure.

System pressure is the differential of pressure between the outlet and inlet ports. It is a dominant operating variable affecting hydraulic unit life. High system pressure, resulting from high load, reduces expected life. System pressure must remain at, or below, rated pressure during normal operation to achieve expected life.

Inlet pressure

Max. continuous vacuum	bar abs.	0.8 [23.6]
Max. intermittent vacuum	[in. Hg]	0.6 [17.7]
Max. pressure		3.0 [88.5]

Time versus pressure

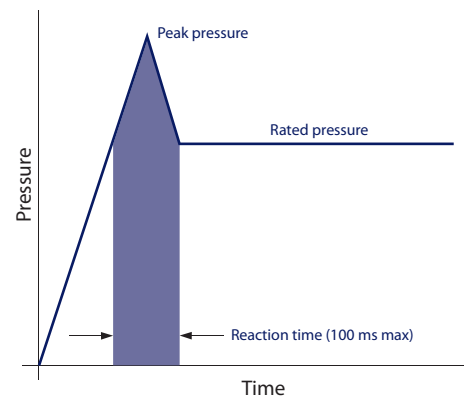

Speed

Maximum speed is the limit recommended by Turolla OCG for a particular gear pump when operating at rated pressure. It is the highest speed at which normal life can be expected.

The lower limit of operating speed is the **minimum speed**. It is the lowest speed at which normal life can be expected. The minimum speed increases as operating pressure increases. When operating under higher pressures, a higher minimum speed must be maintained, as illustrated to the right.

Speed versus pressure

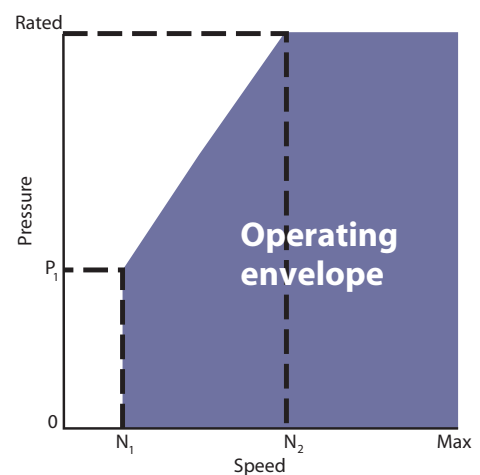

Where:
N₁ = Minimum speed at 100 bar
N₂ = Minimum speed at 180 bar

Group 3 Gear Pumps Technical Information System Requirements

Hydraulic fluids

Ratings and data for SNP3NN and SEP3NN gear pumps are based on operating with premium hydraulic fluids containing oxidation, rust, and foam inhibitors. These fluids must possess good thermal and hydrolytic stability to prevent wear, erosion, and corrosion of internal components. They include:

- Hydraulic fluids following DIN 51524, part 2 (HLP) and part 3 (HVLP) specifications
- API CD engine oils conforming to SAE J183
- M2C33F or G automatic transmission fluids
- Certain agricultural tractor fluids

Use only clean fluid in the pump and hydraulic circuit.

ⓘ Caution

Never mix hydraulic fluids.

Please see Turolla OCG publication *Hydraulic Fluids and Lubricants Technical Information*, **L1021414** for more information. Refer to publication *Experience with Biodegradable Hydraulic Fluids Technical Information*, **L1021903** for information relating to biodegradable fluids.

Temperature and Viscosity

Temperature and viscosity requirements must be concurrently satisfied. Use petroleum / mineral-based fluids.

High temperature limits apply at the inlet port to the pump. The pump should run at or below the maximum continuous temperature. The peak temperature is based on material properties. Don't exceed it.

Cold oil, generally, doesn't affect the durability of pump components. It may affect the ability of oil to flow and transmit power. For this reason, keep the temperature at 16 °C [60 °F] above the pour point of the hydraulic fluid.

Minimum (cold start) temperature relates to the physical properties of component materials.

Minimum viscosity occurs only during brief occasions of maximum ambient temperature and severe duty cycle operation. You will encounter maximum viscosity only at cold start. During this condition, limit speeds until the system warms up. Size heat exchangers to keep the fluid within these limits. Test regularly to verify that these temperatures and viscosity limits aren't exceeded. For maximum unit efficiency and bearing life, keep the fluid viscosity in the recommended viscosity range.

Fluid viscosity

Maximum (cold start)	mm ² /s [SUS]	1000 [4600]
Recommended range		12-60 [66-290]
Minimum		10 [60]

Temperature

Minimum (cold start)	°C [°F]	-20 [-4]
Maximum continuous		80 [176]
Peak (intermittent)		90 [194]

Group 3 Gear Pumps Technical Information System Requirements

Filtration

Filters

Use a filter that conforms to Class 22/18/13 of ISO 4406 (or better). It may be on the pump outlet (pressure filtration), inlet (suction filtration), or reservoir return (return-line filtration).

Selecting a filter

When selecting a filter, please consider:

- contaminant ingress rate (determined by factors such as the number of actuators used in the system)
- generation of contaminants in the system
- required fluid cleanliness
- desired maintenance interval
- filtration requirements of other system components

Measure filter efficiency with a Beta ratio (β_x). For:

- suction filtration, with controlled reservoir ingress, use a $\beta_{35-45} = 75$ filter
- return or pressure filtration, use a pressure filtration with an efficiency of $\beta_{10} = 75$.

β_x ratio is a measure of filter efficiency defined by ISO 4572. It is the ratio of the number of particles greater than a given diameter (x in microns) upstream of the filter to the number of these particles downstream of the filter.

Fluid cleanliness level and β_x ratio

Fluid cleanliness level (per ISO 4406)	Class 22/18/13 or better
β_x ratio (suction filtration)	$\beta_{35-45} = 75$ and $\beta_{10} = 2$
β_x ratio (pressure or return filtration)	$\beta_{10} = 75$
Recommended inlet screen size	100-125 μm [0.004-0.005 in]

The filtration requirements for each system are unique. Evaluate filtration system capacity by monitoring and testing prototypes.

Group 3 Gear Pumps Technical Information System Requirements

Reservoir

The **reservoir** provides clean fluid, dissipates heat, removes entrained air, and allows for fluid volume changes associated with fluid expansion and cylinder differential volumes. A correctly sized reservoir accommodates maximum volume changes during all system operating modes. It promotes deaeration of the fluid as it passes through, and accommodates a fluid dwell-time between 60 and 180 seconds, allowing entrained air to escape.

Minimum reservoir capacity depends on the volume required to cool and hold the oil from all retracted cylinders, allowing for expansion due to temperature changes. A fluid volume of 1 to 3 times the pump output flow (per minute) is satisfactory. The minimum reservoir capacity is 125% of the fluid volume.

Install the suction line above the bottom of the reservoir to take advantage of gravity separation and prevent large foreign particles from entering the line. Cover the line with a 100-125 micron screen. The pump should be below the lowest expected fluid level.

Put the return-line below the lowest expected fluid level to allow discharge into the reservoir for maximum dwell and efficient deaeration. A baffle (or baffles) between the return and suction lines promotes deaeration and reduces fluid surges.

Line sizing

Choose pipe sizes that accommodate minimum fluid velocity to reduce system noise, pressure drops, and overheating. This maximizes system life and performance. Design inlet piping that maintains continuous pump inlet pressure above 0.8 bar absolute during normal operation. The line velocity should not exceed the values in this table:

Maximum line velocity

Inlet		2.5 [8.2]
Outlet	m/s [ft/sec]	5.0 [16.4]
Return		3.0 [9.8]

Most systems use hydraulic oil containing 10% dissolved air by volume. Under high inlet vacuum conditions the oil releases bubbles. They collapse when subjected to pressure, resulting in cavitation, causing adjacent metal surfaces to erode. **Over-aeration** is the result of air leaks on the inlet side of the pump, and flow-line restrictions. These include inadequate pipe sizes, sharp bends, or elbow fittings, causing a reduction of flow line cross sectional area. This problem will not occur if inlet vacuum and rated speed requirements are maintained, and reservoir size and location are adequate.

Group 3 Gear Pumps Technical Information System Requirements

Pump drive

Shaft options for Group 3 gear pumps include tapered, splined, or parallel shafts. They are suitable for a wide range of direct and indirect drive applications for radial and thrust loads.

Plug-in drives, acceptable only with a splined shaft, can impose severe radial loads when the mating spline is rigidly supported. Increasing spline clearance does not alleviate this condition.

Use plug-in drives if the concentricity between the mating spline and pilot diameter is within 0.1 mm [0.004 in]. Lubricate the drive by flooding it with oil. A 3-piece coupling minimizes radial or thrust shaft loads.

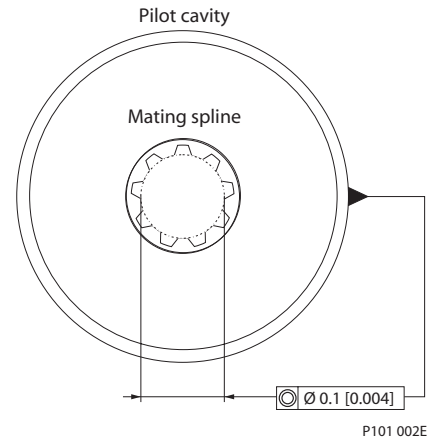

⚠ Caution

In order to avoid spline shaft damages it is recommended to use carburised and hardened steel couplings with 80-82 HRA surface hardness.

Allowable **radial shaft loads** are a function of the load position, load orientation, and operating pressure of the hydraulic pump. All external shaft loads have an effect on bearing life, and may affect pump performance.

In applications where external shaft loads can't be avoided, minimize the impact on the pump by optimizing the orientation and magnitude of the load. Don't use splined shafts for belt or gear drive applications. A spring-loaded belt tension-device is recommended for belt drive applications to avoid excessive tension. Avoid thrust loads in either direction. Contact Turolla OCG if continuously applied external radial or thrust loads occur.

Group 3 Gear Pumps Technical Information System Requirements

Pump drive data form

Photocopy this page and fax the complete form to your Turolia OCG representative for an assistance in applying pumps with belt or gear drive. This illustration shows a pump with counterclockwise orientation:

Optimal radial load position

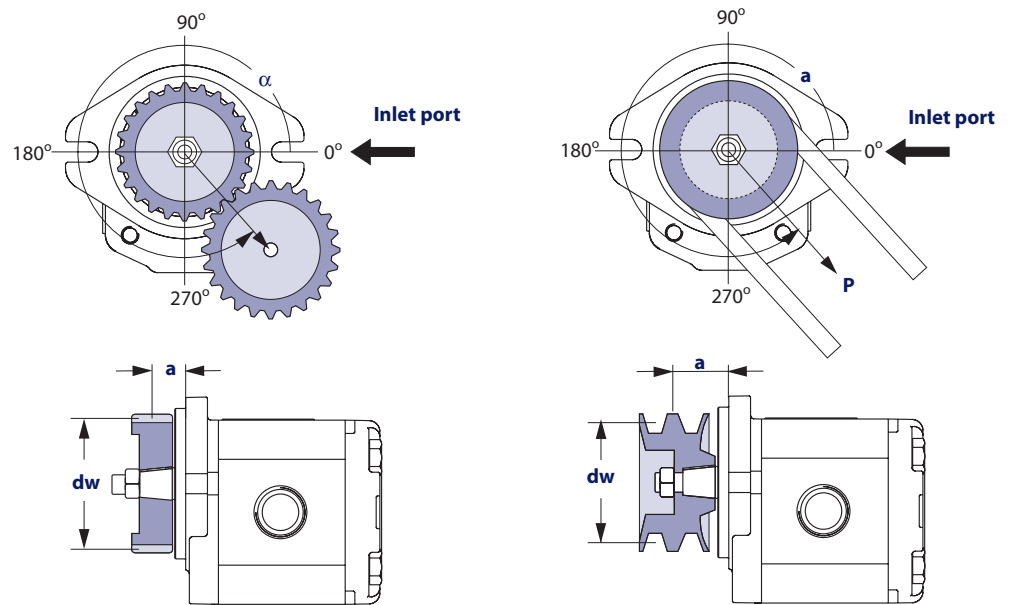

Application data

Item	Value	Unit
Pump displacement		cm ³ /rev [in ³ /rev]
Rated system pressure		<input type="checkbox"/> bar <input type="checkbox"/> psi
Relief valve setting		
Pump shaft rotation		<input type="checkbox"/> left <input type="checkbox"/> right
Pump minimum speed		
Pump maximum speed		min ⁻¹ (rpm)
Drive gear helix angle (gear drive only)		degree
Belt type (gear drive only)		<input type="checkbox"/> V <input type="checkbox"/> notch
Belt tension (gear drive only)	P	<input type="checkbox"/> N <input type="checkbox"/> lbf
Angular orientation of gear or belt to inlet port	α	degree
Pitch diameter of gear or pulley	d_w	<input type="checkbox"/> mm <input type="checkbox"/> in
Distance from flange to center of gear or pulley	a	

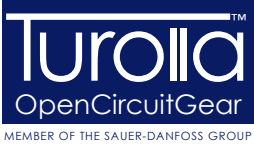

Group 3 Gear Pumps Technical Information System Requirements

Pump life

Pump life is a function of speed, system pressure, and other system parameters (such as fluid quality and cleanliness).

All Turolla OCG gear pumps use hydrodynamic journal bearings that have an oil film maintained between the gear / shaft and bearing surfaces at all times. If the oil film is sufficiently sustained through proper system maintenance and operating within recommended limits, long life can be expected.

B_{10} life expectancy number is generally associated with rolling element bearings.

It does not exist for hydrodynamic bearings.

High pressure, resulting from high loads, impacts pump life. When submitting an application for review, provide machine duty cycle data that includes percentages of time at various loads and speeds. We strongly recommend a prototype testing program to verify operating parameters and their impact on life expectancy before finalizing any system design.

Sound levels

Fluid power systems are inherent generators of noise. As with many high power density devices, noise is an unwanted side effect. However, there are many techniques available to minimize noise from fluid power systems. To apply these methods effectively, it is necessary to understand how the noise is generated and how it reaches the listener. The noise energy can be transmitted away from its source as either fluid borne noise (pressure ripple) or as structure borne noise.

Pressure ripple is the result of the number of pumping elements (gear teeth) delivering oil to the outlet and the pump's ability to gradually change the volume of each pumping element from low to high pressure. In addition, the pressure ripple is affected by the compressibility of the oil as each pumping element discharges into the outlet of the pump. Pressure pulsations will travel along the hydraulic lines at the speed of sound (about 1400 m/s in oil) until affected by a change in the system such as an elbow fitting. Thus the pressure pulsation amplitude varies with overall line length and position.

Structure borne noise may be transmitted wherever the pump casing is connected to the rest of the system. The manner in which one circuit component responds to excitation depends on its size, form, and manner in which it is mounted or supported. Because of this excitation, a system line may actually have a greater noise level than the pump. To reduce this excitation, use flexible hoses in place of steel plumbing. If steel plumbing must be used, clamping of lines is recommended. To minimize other structure borne noise, use flexible (rubber) mounts.

The accompanying graph shows typical sound pressure levels for SNP2NN pumps (with SAE A flange, and spline shaft in plug in drive) measured in dB (A) at 1 m [3.28 ft] from the unit in a semi-anechoic chamber. Anechoic levels can be estimated by subtracting 3 dB (A) from these values.

Contact your Turolla OCG representative for assistance with system noise control.

Pump performance graphs

The graphs on the next few pages provide typical output flow and input power for Group 3 pumps at various working pressures. Data were taken using ISO VG46 petroleum / mineral based fluid at 50 °C [122 °F] (viscosity = 28 mm²/s [132 SUS]).

SNP3NN/022 pump performance graph

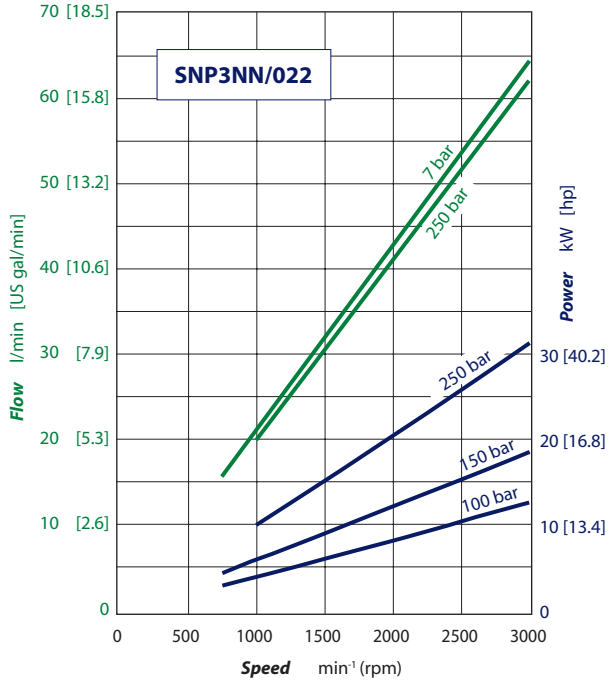

SNP3NN/026 pump performance graph

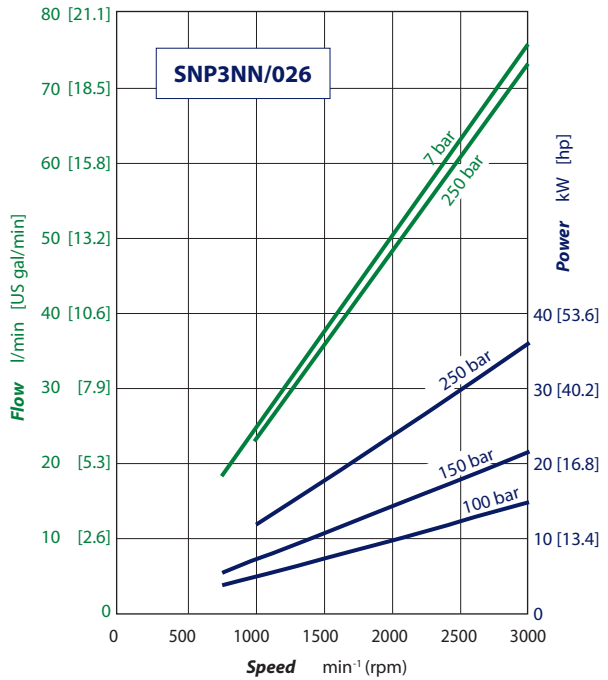

SNP3NN/033 pump performance graph

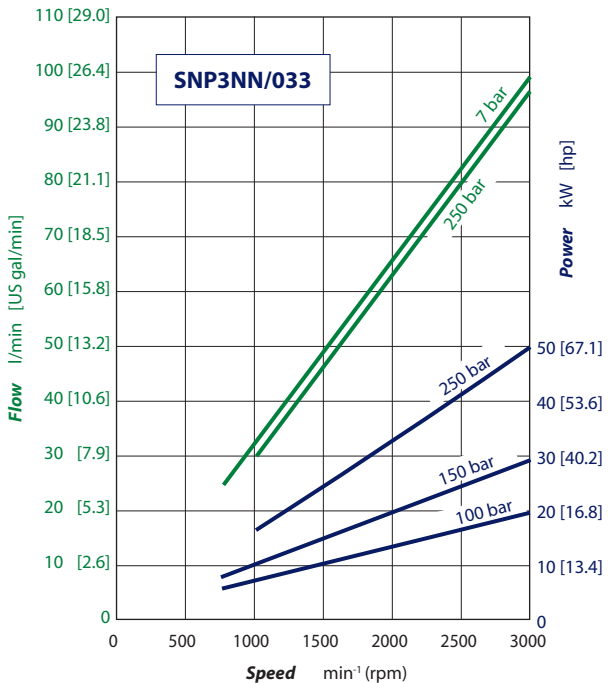

SNP3NN/038 pump performance graph

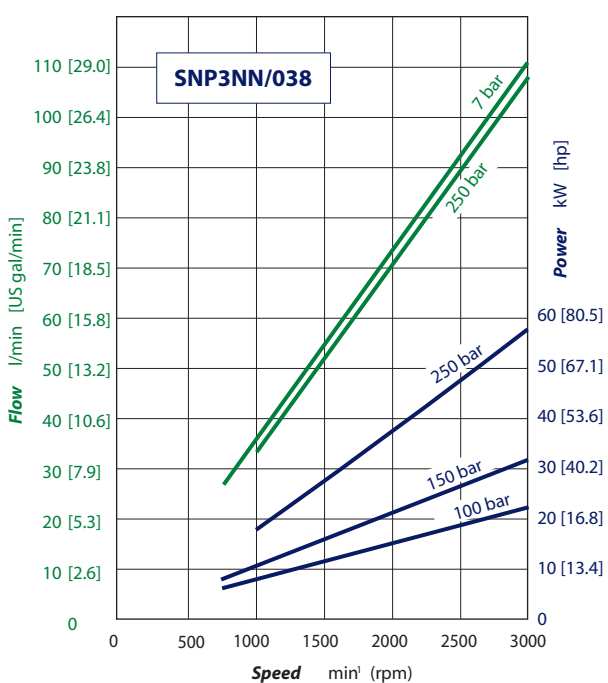

Pump performance graphs (continued)

SNP3NN/044 pump performance graph

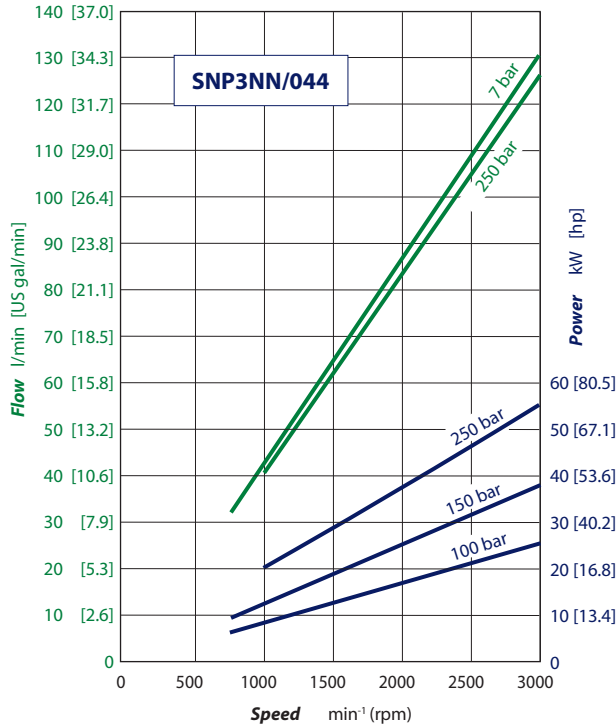

SNP3NN/048 pump performance graph

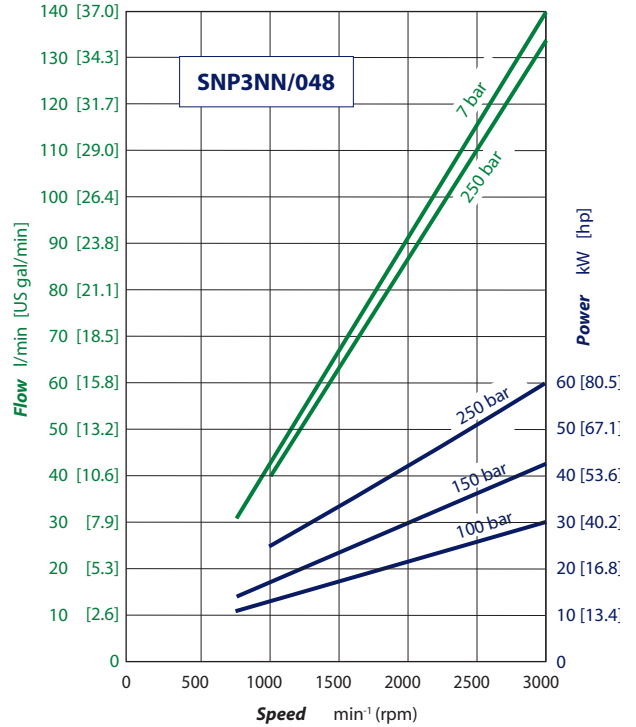

SNP3NN/055 pump performance graph

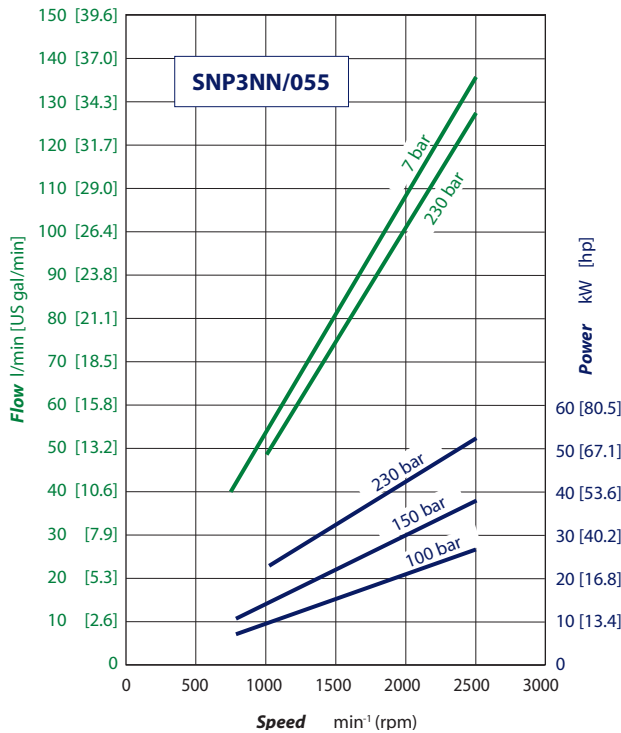

SNP3NN/063 pump performance graph

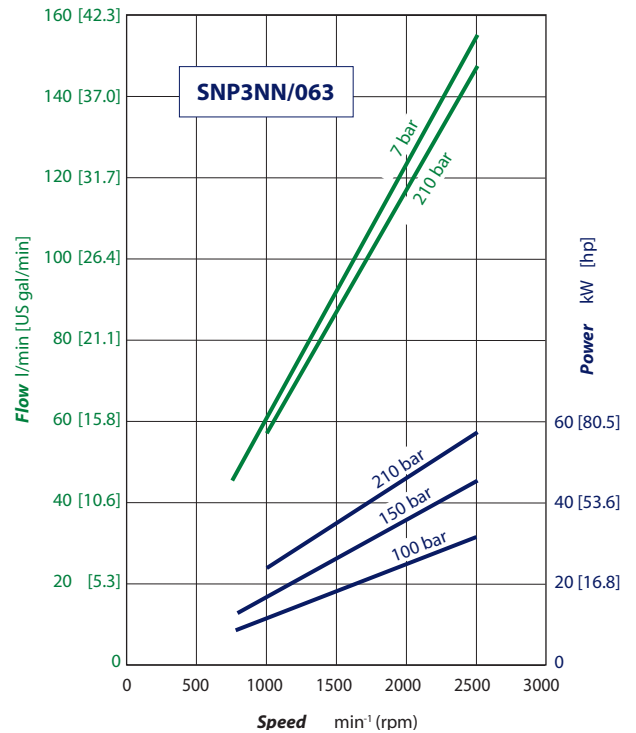

Pump performance graphs (continued)

SNP3NN/075 pump performance graph

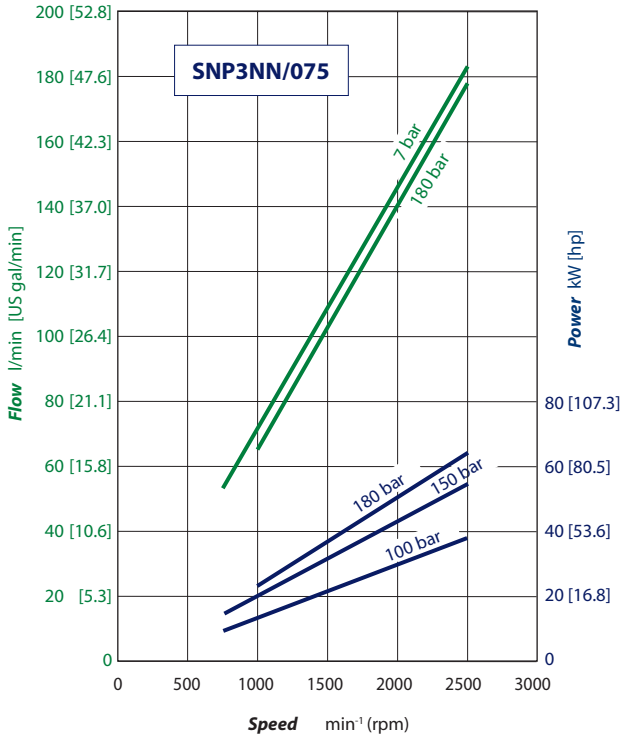

SNP3NN/090 pump performance graph

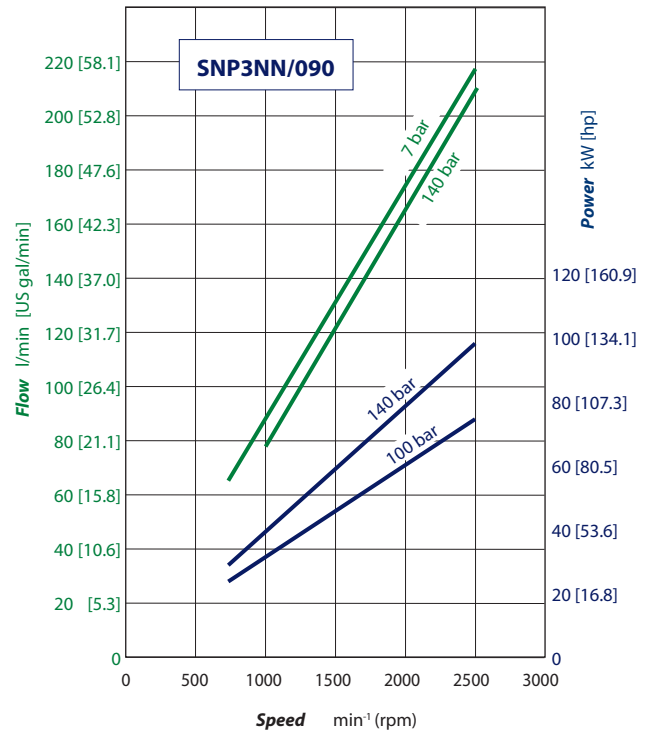

SEP3NN/022 pump performance graph

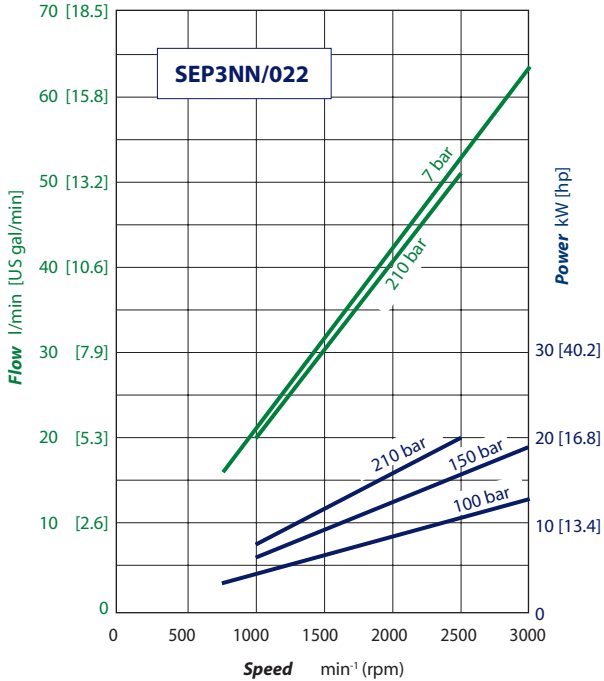

SEP3NN/026 pump performance graph

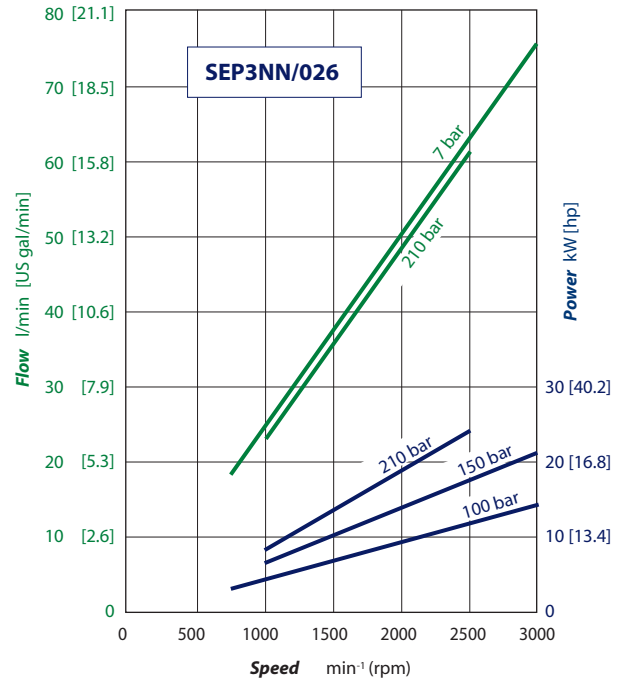

Pump performance graphs (continued)

SEP3NN/033 pump performance graph

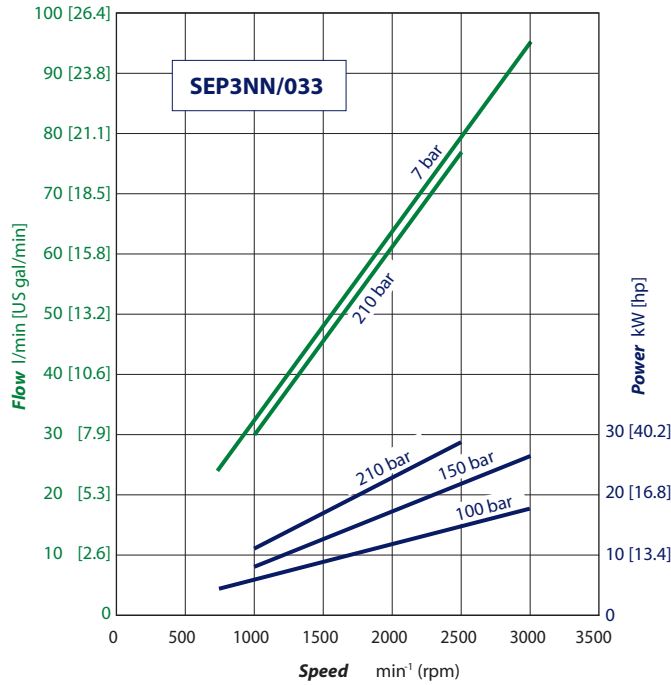



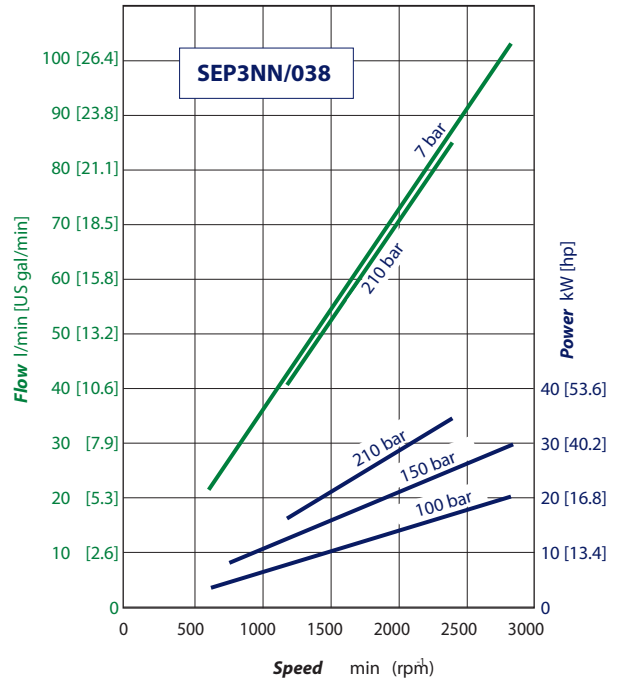

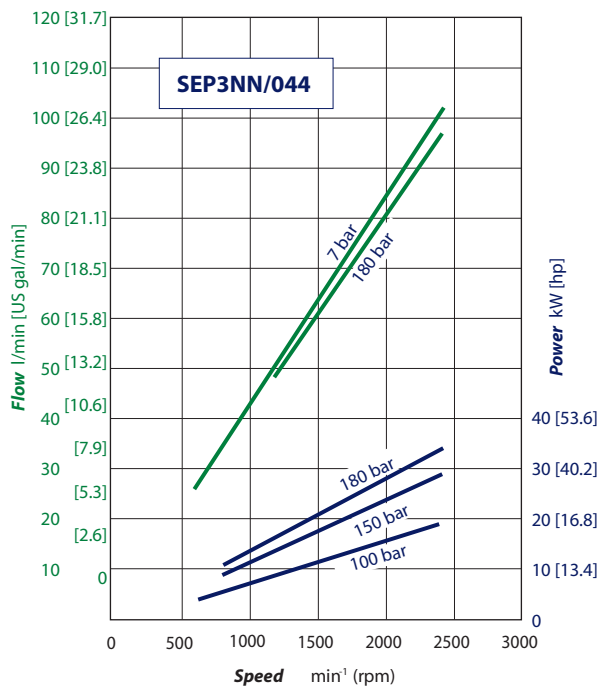

SEP3NN/038 pump performance graph

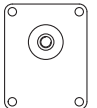

SEP3NN/044 pump performance graph

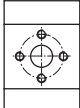
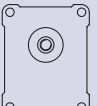
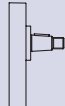
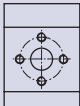
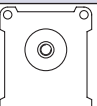
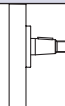
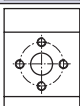

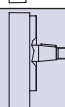
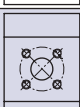
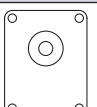
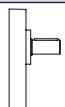
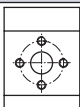
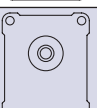
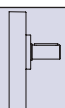
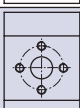
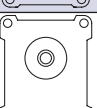
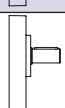
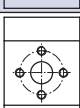
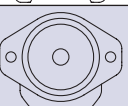
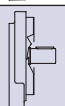
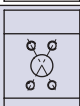
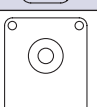
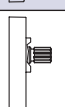
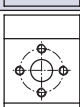
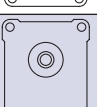
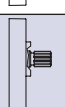
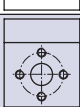
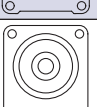
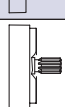
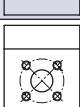
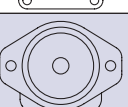
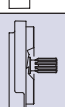
Shaft, flange, and port configurations

Pump	Code	Flange	Shaft	Port
SEP3NN SNP3NN	01BA	pilot Ø 50.8 mm [2.0 in] European 01, 4-bolt 	1:8 tapered 	European flanged port + pattern 
SNP3NN	02BA	pilot Ø 50.8 mm [2.0 in] European 02, 4-bolt 	1:8 tapered 	European flanged port + pattern 
SNP3NN	03BB	pilot Ø 60.3 mm [2.374 in] European 03, 4-bolt 	1:8 tapered 	European flanged port + pattern 
SNP3NN	06AA	pilot Ø 105 mm [4.133 in] German, 4-bolt 	1:5 tapered 	German std ports port X pattern 
SEP3NN SNP3NN	01FA	pilot Ø 50.8 mm [2.0 in] European 01, 4-bolt 	Ø 20 mm [0.787 in] parallel 	European flanged port + pattern 
SNP3NN	02FA	pilot Ø 50.8 mm [2.0 in] European 02, 4-bolt 	Ø 20 mm [0.787 in] parallel 	European flanged port + pattern 
SNP3NN	03FB	pilot Ø 60.3 mm [2.374 in] European 03, 4-bolt 	Ø 22 mm [0.866 in] parallel 	European flanged port + pattern 
SEP3NN SNP3NN	07GA	pilot Ø 101.6 mm [4.0 in] SAE B, 2-bolt 	Ø 22.225 mm [0.875 in] parallel 	Vertical four bolt flanged port 
SNP3NN	01DA	pilot Ø 50.8 mm [2.0 in] European 01, 4-bolt 	Splined shaft 13T - m 1.60 DIN 5482-B22x19 	European flanged port + pattern 
SNP3NN	02DA	pilot Ø 50.8 mm [2.0 in] European 02, 4-bolt 	Splined shaft 13T - m 1.60 DIN 5482-B22x19 	European flanged port + pattern 
SNP3NN	06DD	pilot Ø 105 mm [4.0 in] German, 4-bolt 	Splined shaft 15T - m 1.75 DIN 5482-B28x25 	German std ports port X pattern 
SEP3NN SNP3NN	07SA	pilot Ø 101.6 mm [4.0 in] SAE B, 2-bolt 	Splined shaft SAE J498 13T - 16/32DP 	Vertical four bolt flanged port 

Mounting flanges

Turolla OCG offers many types of industry standard mounting flanges. This table shows order codes for each available mounting flange and its intended use:

Flange availability



Code	Description
01	European 50.8 mm [2.0 in] 4-bolt
02	
03	European 60.3 mm [2.374 in] 4-bolt
06	German 105 mm [4.134 in] 4-bolt
07	SAE B 2-bolt

Shaft options

Direction is viewed facing the shaft. Group 3 pumps are available with a variety of splined, parallel, and tapered shaft ends. Not all shaft styles are available with all flange styles.

Shaft availability and nominal torque capability



Code	Shaft Description	Mounting flange code with maximum torque in Nm [lb-in]				
		01	02	03	06	07
AA	Taper 1:5	-	-	-	300 [2655]	-
BA	Taper 1:8	350 [3097]	350 [3097]	-	-	-
BB	Taper 1:8	-	-	500 [4425]	-	-
DA	Spline 13T DIN 5482-B22X19	290 [2566]	290 [2566]	-	-	-
DD	Spline 13T DIN 5482-B28X25	-	-	-	450 [3982]	-
SA	SAE spline 13T 16/32p	-	-	-	-	270 [2389]
FA	Parallel ø20 mm	210 [1858]	210 [1858]	-	-	-
FB	Parallel ø22.225 mm	-	-	300 [2655]	-	-
GA	Parallel ø22.225 mm	-	-	-	-	230 [2035]

Turolla OCG recommends mating splines conform to SAE J498 or DIN 5482. Turolla OCG external SAE splines have a flat root side fit with circular tooth thickness reduced by 0.127 mm [0.005 in] in respect to class 1 fit. Dimensions are modified to assure a clearance fit with the mating spline.

⚠ Caution

Shaft torque capability may limit allowable pressure. Torque ratings assume no external radial loading. Applied torque must not exceed these limits, regardless of stated pressure parameters. Maximum torque ratings are based on shaft torsional fatigue strength.

Group 3 Gear Pumps Technical Information Product Options

Port configurations

Various port configurations are available on Group 3 pumps. They include:

- European standard flanged ports
- German standard flanged ports
- Gas threaded ports (BSPP)
- O-Ring boss (following SAE J1926/1 [ISO 11926-1] UNF threads, standard)

A table of dimensions is on the next page.

Available port configurations

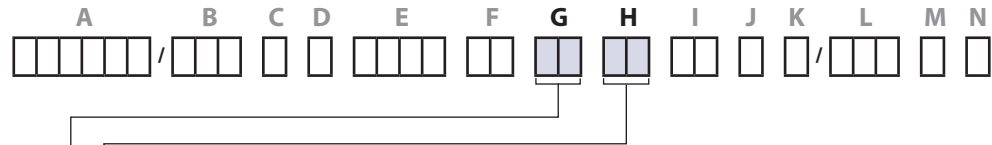

G Inlet port

Code	Description	
A2	8,5x22,23x47,63x $\frac{3}{8}$ -16UNC	SAE flanged port
A3	25x26,19x52,37x $\frac{3}{8}$ -16UNC	
A4	31x30,18x58,72x $\frac{7}{16}$ -14UNC	
A5	37,5/27x35,7x69,85x $\frac{1}{2}$ -13UNC	
B7	20x40xM6	Flanged port with thd holes in X pattern
BA	18x55xM8	
BB	27x55xM8	
BC	36/27x55xM8	
C3	13,5x30xM6	Flanged port with thd holes in + pattern
C7	20x40xM8	
CA	27x51xM10	
CD	36x62xM10	
E6	1 $\frac{1}{16}$ -12UN	Thd SAE O-ring boss port
E8	1 $\frac{5}{16}$ -12UN	
E9	1 $\frac{5}{8}$ -12UN	
EA	1 $\frac{7}{8}$ -12UN	
F5	$\frac{3}{4}$ GAS	Threaded GAS (BSPP)
F6	1 GAS	
F7	1 $\frac{1}{4}$ GAS	

H Outlet port

For code letters and descriptions see *the table above*.

Porting

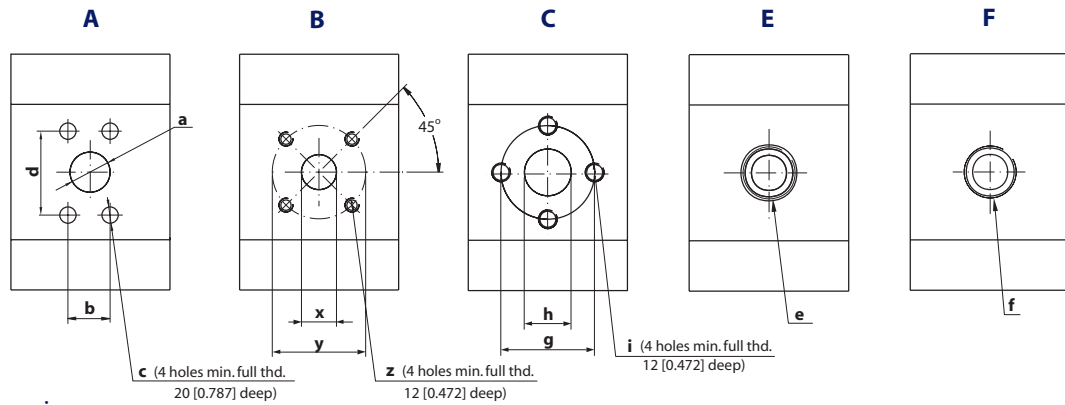

Ports dimensions

Port type		A			B			C			E	F	
Dimensions		a	b	d	c	x	y	z	g	h	i	e	f
022	Inlet	25.4 [1.000]	26.19 [1.031]	52.37 [2.062]	3/8-16UNC-2B	27 [1.063]	55 [2.165]	M8	40 [1.575]	20 [0.787]	M8	1 ⁵ / ₁₆ -12UN-2B	3/4 Gas (BSPP)
	Outlet	19.1 [0.752]	22.23 [0.875]	47.63 [1.875]	3/8-16UNC-2B	18 [0.709]	55 [2.165]	M8	40 [1.575]	20 [0.787]	M8	1 ¹ / ₁₆ -12UN-2B	3/4 Gas (BSPP)
026	Inlet	25.4 [1.000]	26.19 [1.031]	52.37 [2.062]	3/8-16UNC-2B	27 [1.063]	55 [2.165]	M8	40 [1.575]	20 [0.787]	M8	1 ⁵ / ₁₆ -12UN-2B	3/4 Gas (BSPP)
	Outlet	19.1 [0.752]	22.23 [0.875]	47.63 [1.875]	3/8-16UNC-2B	18 [0.709]	55 [2.165]	M8	40 [1.575]	20 [0.787]	M8	1 ¹ / ₁₆ -12UN-2B	3/4 Gas (BSPP)
033	Inlet	31.8 [1.252]	30.18 [1.188]	58.72 [2.312]	7/16-14UNC-2B	27 [1.063]	55 [2.165]	M8	51 [2.008]	27 [1.063]	M10	1 ⁵ / ₈ -12UN-2B	1 Gas (BSPP)
	Outlet	25.4 [1.000]	26.19 [1.031]	52.37 [2.062]	3/8-16UNC-2B	18 [0.709]	55 [2.165]	M8	40 [1.575]	20 [0.787]	M8	1 ⁵ / ₁₆ -12UN-2B	3/4 Gas (BSPP)
038	Inlet	31.8 [1.252]	30.18 [1.188]	58.72 [2.312]	7/16-14UNC-2B	27 [1.063]	55 [2.165]	M8	51 [2.008]	27 [1.063]	M10	1 ⁵ / ₈ -12UN-2B	1 Gas (BSPP)
	Outlet	25.4 [1.000]	26.19 [1.031]	52.37 [2.062]	3/8-16UNC-2B	18 [0.709]	55 [2.165]	M8	40 [1.575]	20 [0.787]	M8	1 ⁵ / ₁₆ -12UN-2B	3/4 Gas (BSPP)
044	Inlet	31.8 [1.252]	30.18 [1.188]	58.72 [2.312]	7/16-14UNC-2B	27 [1.063]	55 [2.165]	M8	51 [2.008]	27 [1.063]	M10	1 ⁵ / ₈ -12UN-2B	1 Gas (BSPP)
	Outlet	25.4 [1.000]	26.19 [1.031]	52.37 [2.062]	3/8-16UNC-2B	18 [0.709]	55 [2.165]	M8	51 [2.008]	27 [1.063]	M10	1 ⁵ / ₁₆ -12UN-2B	1 Gas (BSPP)
048	Inlet	31.8 [1.252]	30.18 [1.188]	58.72 [2.312]	7/16-14UNC-2B	27 [1.063]	55 [2.165]	M8	51 [2.008]	27 [1.063]	M10	1 ⁵ / ₈ -12UN-2B	1 Gas (BSPP)
	Outlet	25.4 [1.000]	26.19 [1.031]	52.37 [2.062]	3/8-16UNC-2B	18 [0.709]	55 [2.165]	M8	51 [2.008]	27 [1.063]	M10	1 ⁵ / ₁₆ -12UN-2B	1 Gas (BSPP)
055	Inlet	38.1 [1.500]	35.71 [1.406]	69.85 [2.750]	1/2-13UNC-2B	27 [1.063]	55 [2.165]	M8	51 [2.008]	27 [1.063]	M10	1 ⁷ / ₈ -12UN-2B	1 Gas (BSPP)
	Outlet	31.8 [1.252]	30.18 [1.188]	58.72 [2.312]	7/16-14UNC-2B	18 [0.709]	55 [2.165]	M8	51 [2.008]	27 [1.063]	M10	1 ⁵ / ₈ -12UN-2B	1 Gas (BSPP)
063	Inlet	38.1 [1.500]	35.71 [1.406]	69.85 [2.750]	1/2-13UNC-2B	36 [1.417]	55 [2.165]	M8	62 [2.441]	36 [1.417]	M10	1 ⁷ / ₈ -12UN-2B	1 1/4 Gas (BSPP)
	Outlet	31.8 [1.252]	30.18 [1.188]	58.72 [2.312]	7/16-14UNC-2B	27 [1.063]	55 [2.165]	M8	51 [2.008]	27 [1.063]	M10	1 ⁵ / ₈ -12UN-2B	1 Gas (BSPP)
075	Inlet	38.1 [1.500]	35.71 [1.406]	69.85 [2.750]	1/2-13UNC-2B	36 [1.417]	55 [2.165]	M8	62 [2.441]	36 [1.417]	M10	1 ⁷ / ₈ -12UN-2B	1 1/4 Gas (BSPP)
	Outlet	31.8 [1.252]	30.18 [1.188]	58.72 [2.312]	7/16-14UNC-2B	27 [1.063]	55 [2.165]	M8	51 [2.008]	27 [1.063]	M10	1 ⁵ / ₈ -12UN-2B	1 Gas (BSPP)
090	Inlet	38.1 [1.500]	35.71 [1.406]	69.85 [2.750]	1/2-13UNC-2B	36 [1.417]	55 [2.165]	M8	62 [2.441]	36 [1.417]	M10	1 ⁷ / ₈ -12UN-2B	1 1/4 Gas (BSPP)
	Outlet	31.8 [1.252]	30.18 [1.188]	58.72 [2.312]	7/16-14UNC-2B	27 [1.063]	55 [2.165]	M8	51 [2.008]	27 [1.063]	M10	1 ⁵ / ₈ -12UN-2B	1 Gas (BSPP)

SNP3NN – 01FA, 01DA, 01BA / SEP3NN – 01BA

The drawing shows the SNP3NN standard porting for 01FA, 01DA and 01BA. The configurations 01FA and 01BA are available for the SEP3NN.

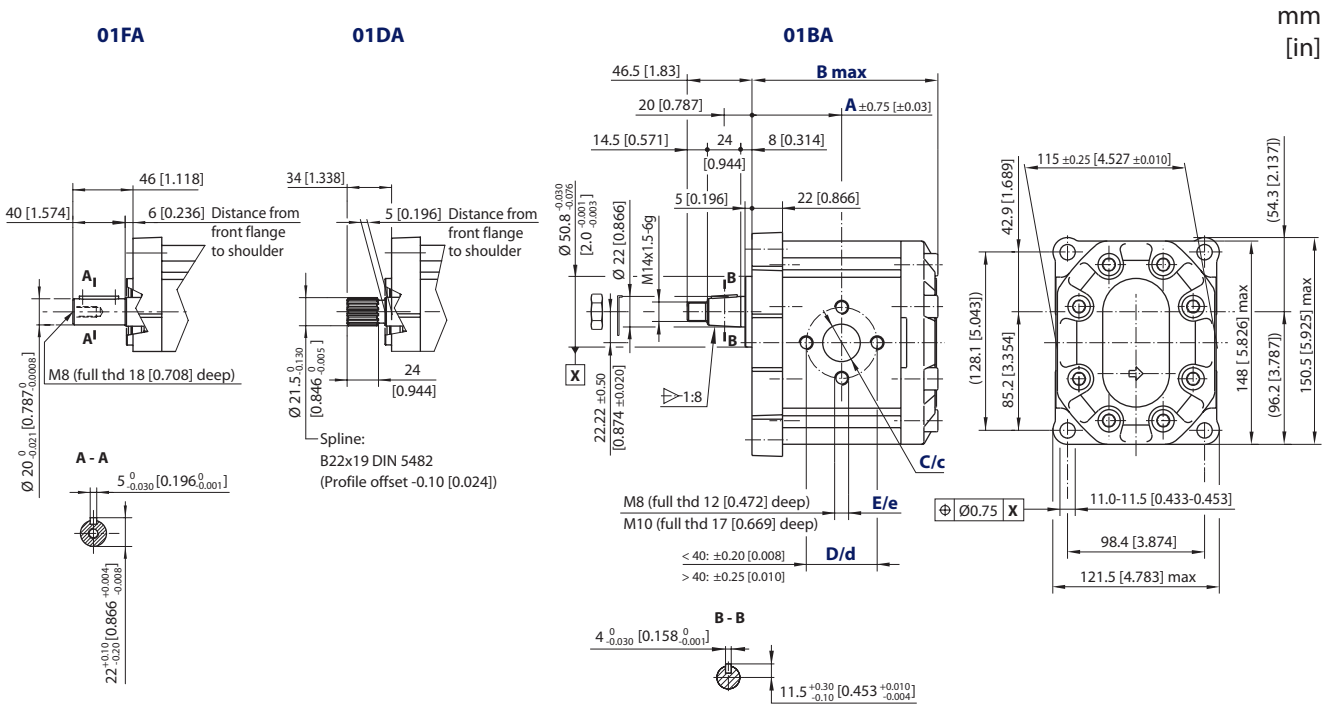

SNP3NN – 01FA, 01BA, 01DA and SEP3NN – 01FA, 01BA dimensions

Frame size	022	026	033	038	044	048	055	063	075	090	
Dimension	A	63 [2.480]	64.5 [2.539]	67 [2.637]	68.8 [2.708]	71 [2.795]	72.5 [2.854]	75 [2.952]	78 [3.07]	82 [3.228]	87 [3.425]
	B	132.5 [5.216]	135.5 [5.334]	140.5 [5.531]	144 [5.669]	148.5 [5.846]	151.5 [5.964]	156.5 [6.161]	162.5 [6.397]	170.5 [6.712]	180.5 [7.106]
Inlet	C	20 [0.787]		27 [1.063]			36 [1.417]				
	D	40 [1.575]		51 [2.007]			62 [2.441]				
	E	M8			M10						
Outlet	c	20 [0.787]				27 [1.063]					
	d	40 [1.575]				51 [2.001]					
	e	M8				M10					

The SEP3NN overall length is 12 mm [0.472 in] less than the SNP3NN for the whole range of displacements (22.1 to 44.1 cm³/rev [1.35 to 2.69 in³/rev]).

Model code examples and maximum shaft torque

Flange/drive gear	Model code example	Maximum shaft torque
01DA	SNP3NN/075LN01DAP1CDCANNNN/NNNNN	290 N•m [2566 lb•in]
01FA	SNP3NN/033RN01FAP1CAC7NNNN/NNNNN	210 N•m [1858 lb•in]
01BA	SNP3NN/022RN01BAP1C7C7NNNN/NNNNN	350 N•m [3097 lb•in]

For further details on ordering, see *Model Code*, pages 8÷9.

SNP3NN – 02FA, 02DA and 02BA

This drawing shows the standard porting for 02FA, 02DA and 02BA.

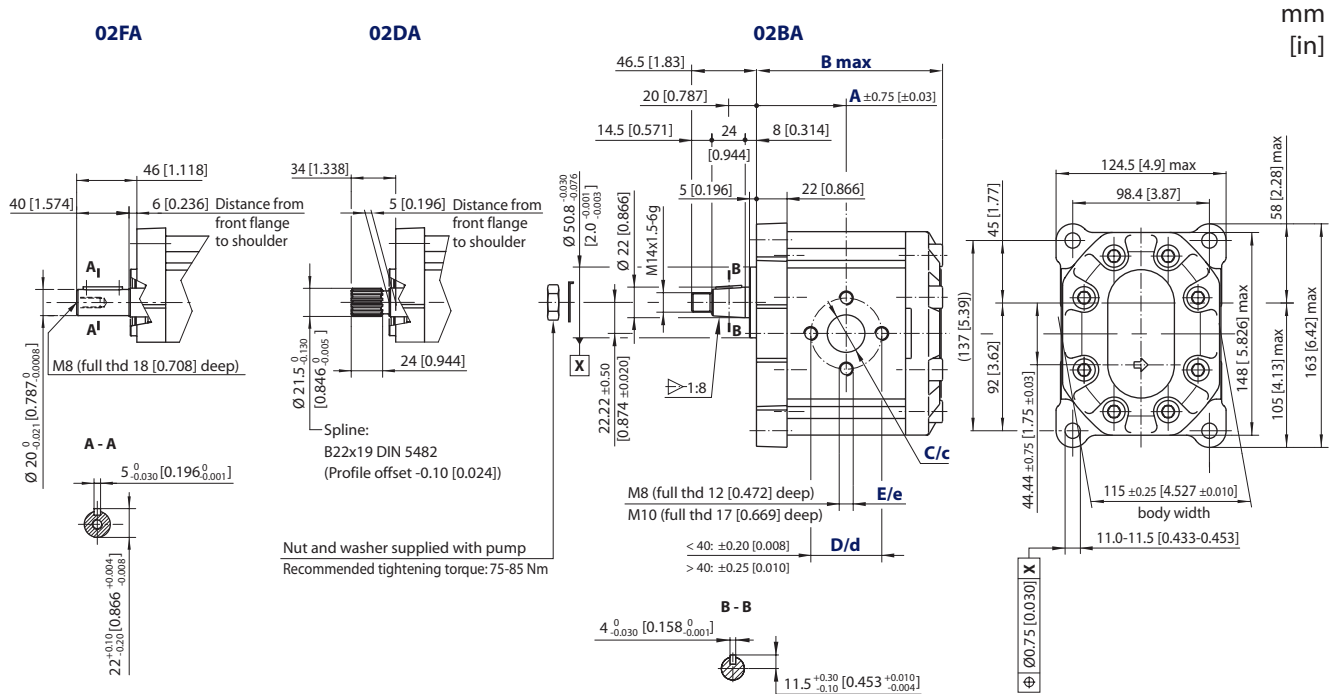

SNP3NN – 02FA, 02DA and 02BA dimensions

Frame size	022	026	033	038	044	048	055	063	075	090	
Dimension	A	63 [2.480]	64.5 [2.539]	67 [2.637]	68.8 [2.708]	71 [2.795]	72.5 [2.854]	75 [2.952]	78 [3.07]	82 [3.228]	87 [3.425]
	B	132.5 [5.216]	135.5 [5.334]	140.5 [5.531]	144 [5.669]	148.5 [5.846]	151.5 [5.964]	156.5 [6.161]	162.5 [6.397]	170.5 [6.712]	180.5 [7.106]
Inlet	C	20 [0.787]		27 [1.063]			36 [1.417]				
	D	40 [1.575]		51 [2.007]			62 [2.441]				
	E	M8					M10				
Outlet	c	20 [0.787]			27 [1.063]						
	d	40 [1.575]			51 [2.001]						
	e	M8						M10			

Model code examples and maximum shaft torque

Flange/drive gear configuration	Model code example	Maximum shaft torque N·m [lb·in]
02FA	SNP3NN/044RN02FAP1CACANNNN/NNNNN	210 [1858]
02DA	SNP3NN/033RN02DAP1CAC7NNNN/NNNNN	290 [2566]
02BA	SNP3NN/026LN02BAP1C7C7NNNN/NNNNN	350 [3097]

For further details on ordering, see *Model Code*, pages 8÷9.

SNP3NN – 03FB, 03BB

This drawing shows the standard porting for 03FB and 03BB.

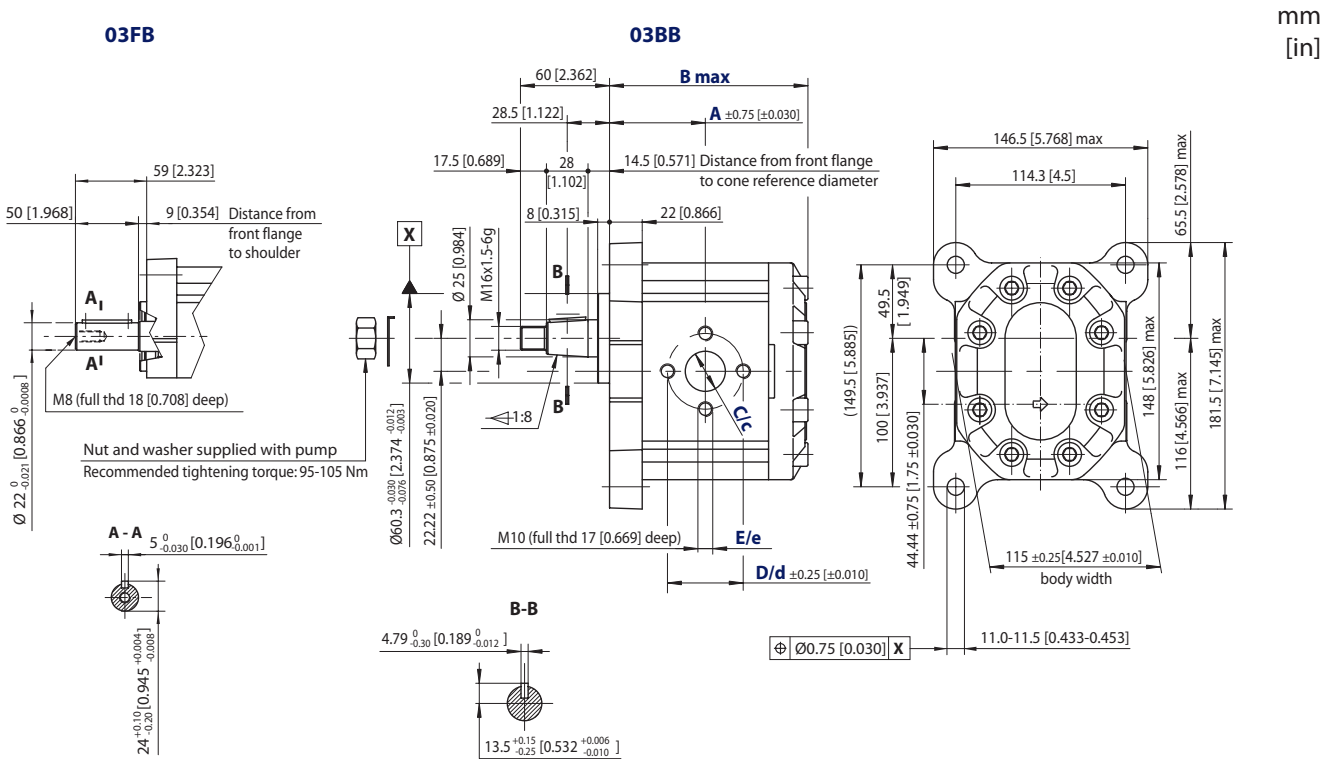

SNP3NN – 03FB and 03BB dimensions

Type (displacement)	022	026	033	038	044	048	055	063	075	090	
Dimension	A	63.0 [2.480]	64.5 [2.539]	67.0 [2.637]	68.8 [2.708]	71.0 [2.795]	72.5 [2.854]	75.0 [2.952]	78.0 [3.070]	82.0 [3.228]	87.0 [3.425]
	B	132.5 [5.216]	135.5 [5.334]	140.5 [5.531]	144.0 [5.669]	148.5 [5.846]	151.5 [5.964]	156.5 [6.161]	162.5 [6.397]	170.5 [6.712]	180.5 [7.106]
Inlet	C	20 [0.787]		27 [1.063]			36 [1.417]				
	D	40 [1.575]		51 [2.007]			62 [2.441]				
	E	M8		M10							
Outlet	c	20 [0.787]			27 [1.063]						
	d	40 [1.575]			51 [2.001]						
	e	M8			M10						

Model code examples and maximum shaft torque

Flange/drive gear configuration	Model code example	Maximum shaft torque N·m [lb·in]
03FB	SNP3NN/044LN03FBP1CACANNNN/NNNNN	300 [2655]
03BB	SNP3NN/090RN03BBP1CDCANNNN/NNNNN	500 [4425]

For further details on ordering, see *Model Code*, pages 8÷9.

SNP3NN – 06DD, 06AA

This drawing shows the standard porting for 06DD and 06AA.

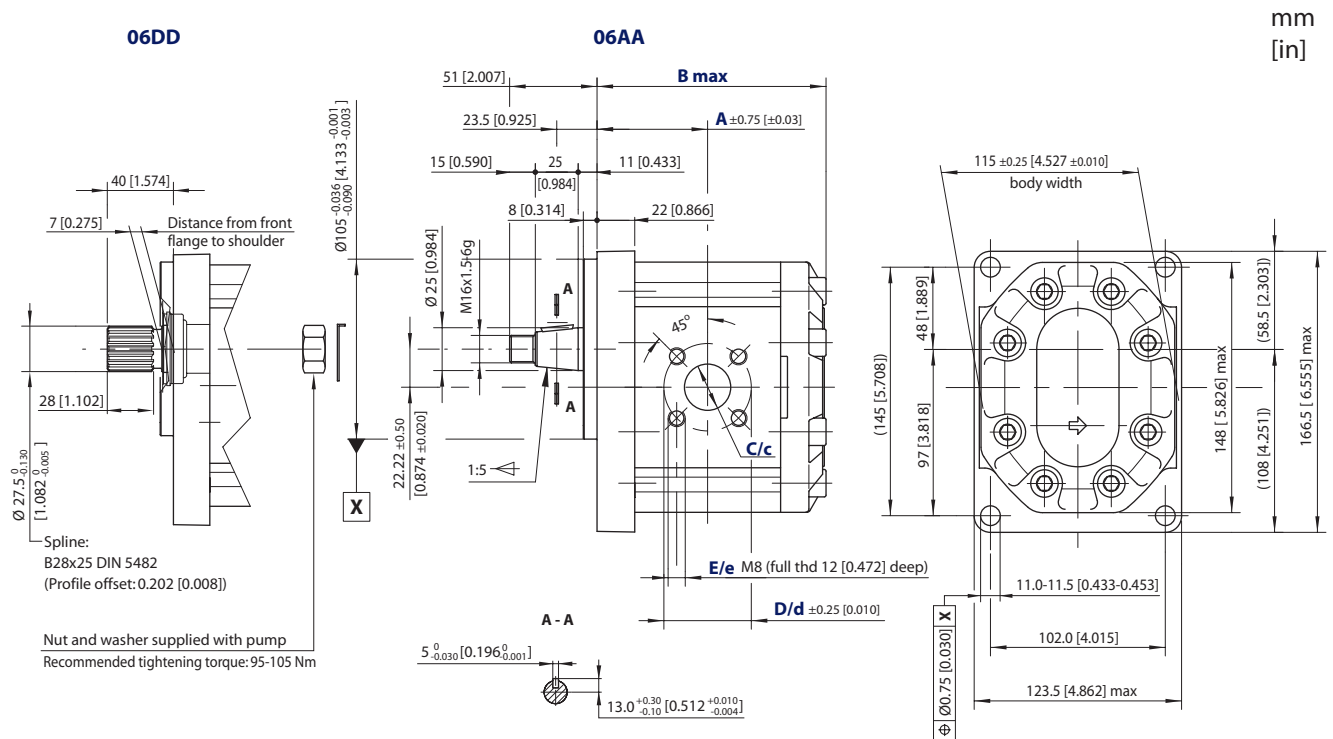

SNP3NN – 06DD and 06AA dimensions

Type (displacement)	022	026	033	038	044	048	055	063	075	090	
Dimension	A	63.0 [2.480]	64.5 [2.539]	67.0 [2.637]	68.8 [2.708]	71.0 [2.795]	72.5 [2.854]	75.0 [2.952]	78.0 [3.070]	82.0 [3.228]	87.0 [3.425]
	B	132.5 [5.216]	135.5 [5.334]	140.5 [5.531]	144.0 [5.669]	148.5 [5.846]	151.5 [5.964]	156.5 [6.161]	162.5 [6.397]	170.5 [6.712]	180.5 [7.106]
Inlet	C	27 [1.063]						36 [1.417]			
	D	55 [2.165]									
	E	M8									
Outlet	c	18 [0.708]						27 [1.063]			
	d	55 [2.165]									
	e	M8									

Model code examples and maximum shaft torque

Flange/drive gear configuration	Model code example	Maximum shaft torque N·m [lb·in]
06DD	SNP3NN/044RN06DDP1BBBANNNN/NNNNN	450 [3982]
06AA	SNP3NN/026LN06AAP1BBBANNNN/NNNNN	300 [2655]

For further details on ordering, see *Model Code*, pages 8÷9.

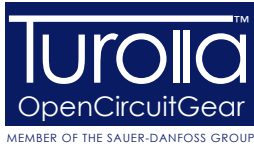

Group 3 Gear Pumps Technical Information Dimensions

SNP3NN and SEP3NN – 07SA, 07GA (cont.)

Model code examples and maximum shaft torque

Flange/drive gear configuration	Model code example	Maximum shaft torque N·m [lb·in]
07SA	SNP3NN/063LN07SAP1A5A4NNNN/NNNNN	270 [2389]
07GA	SNP3NN/026LN07GAP1A3A2NNNN/NNNNN	230 [2035]

For further details on ordering, see *Model Code*, pages 8÷9.

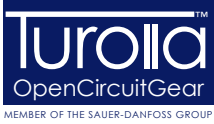

Our Products

Aluminum Gear Pumps

Aluminum Gear Motors

Cast Iron Gear Pumps

Cast Iron Gear Motors

Fan Drive Gear Motors Aluminum

Fan Drive Gear Motors Cast Iron

Turolla OpenCircuitGear™

Turolla OCG, with more than 60 years of experience in designing and manufacturing gear pumps, gear motors and fan drive motors of superior quality, is the ideal partner ensuring robustness and reliability to your work functions.

We are fast and responsive - the first to specify a customer product, the most experienced in providing technical knowledge and support for fan drive solutions.

We offer a lean value chain to our partners and customers and the shortest lead time in the market.

Turolla OCG is member of the Sauer-Danfoss Group.

Local address:

Turolla OpenCircuitGear

Via Villanova 28
40050 Villanova di Castenaso
Bologna, Italy
Phone: +39 051 6054411
Fax: +39 051 6053033

Turolla OpenCircuitGear

Kukučínova 2148-84
01701 Považská Bystrica, Slovakia
Phone: +421 424 301 544
Fax: +421 424 301 626

Turolla OpenCircuitGear

2800 East 13th Street
Ames, IA 50010
USA
Phone: +1 515 239 6000
Fax: +1 515 239 6618